

FABER

TOASTER OVEN FEO IVORY 108

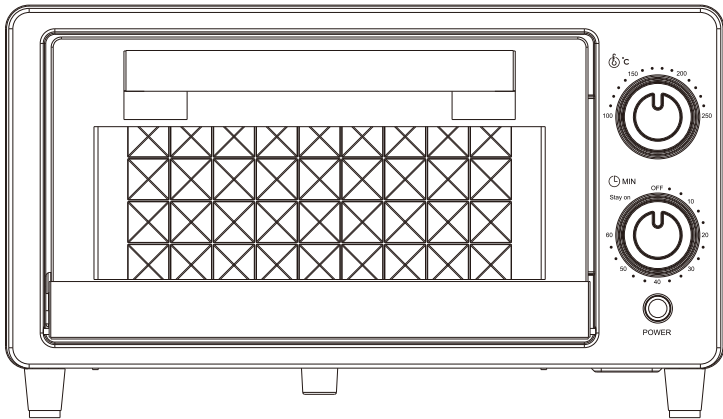

POWER RATED: 800W VOLTAGE: 220-240V~ FREQUENCY: 50-60Hz

INSTRUCTIONS MANUAL

PLEASE READ THIS INSTRUCTIONS MANUAL CAREFULLY BEFORE USING THIS PRODUCT

TOASTER OVEN

General Safety Precautions

1. This appliance is not intended for use by persons (including children) with reduced physical, sensory, or mental capabilities, or lack of experience and knowledge, unless they have been given supervision or instruction concerning the use of the appliance by a person responsible for their safety.
2. This appliance is intended for indoor and household use only, not for outdoor, commercial, or industrial use.
3. Keep the appliance and its power cord out of reach of children. Children should be supervised to ensure that they do not play with the appliance.
4. Do not use or place the appliance in a sink, on a hot surface, near a heat source, or near the edge of a table or counter.
5. To protect against fire, electric shock, and injury, do not immerse the power cord, plug, or appliance in water or other liquids.
6. Ensure that the voltage indicated on the Rating Label corresponds to the local power supply.
7. Do not leave the appliance operating unattended for an extended period of time.
8. Always place the appliance on a flat, level, and dry surface.
9. The appliance must be switched off and the mains plug removed from the wall socket after each use, and before cleaning and maintenance.

PARTS INDICATION

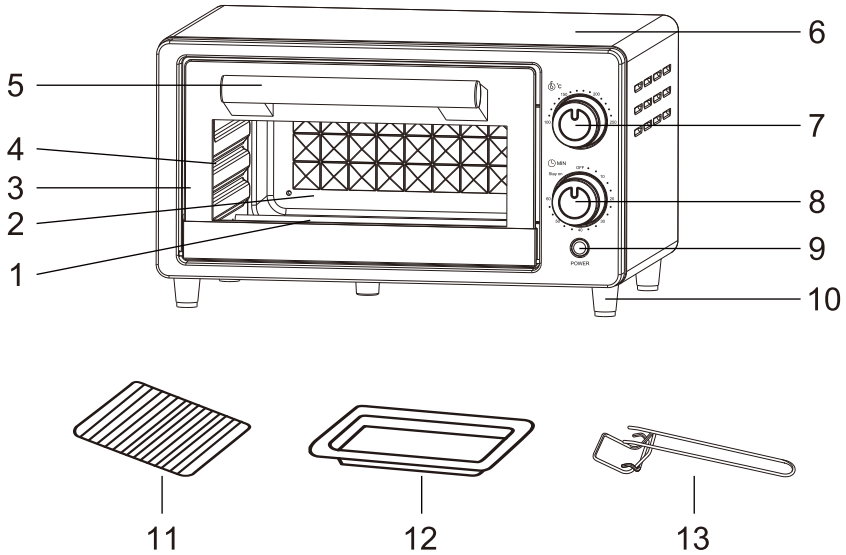

1. Heating Element	6. Outer Case	11. Wire Rack
2. Inner Case	7. Temperature Knob	12. Baking Tray
3. Glass Door	8. Timer Knob	13. Tray Handle
4. Rack Support	9. Indicator Light	
5. Door Handle	10. Foot	

PARAMETER DATA

MODEL NO.	FEO IVORY 108
POWER SUPPLY	220-240V~ 50-60Hz
POWER CONSUME	800W
Liter	10L

CAUTIONS



Always use the food fork when inserting or removing the tray. Touching these will cause severe burns.

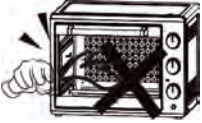

When hot, do not apply water to the glass window. It may cause the glass to break.



When unplugging the cord, always take hold of the plug itself. Never pull on the cord. Doing so could break the wires inside the cord.

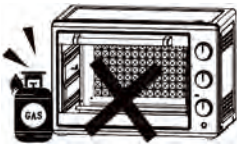

Do not position the unit close to a gas burner or other source of high temperature or do not direct an electric fan, etc, at the unit during **USE**. Doing so could prevent correct temperature control.







Do not wet the power cord nor handle the unit with wet hands. Always unplug the cord after use, or whenever the unit is to be left unattended. A malfunction while the plug is inserted into the outlet could cause a fire.

When cooking oil-splashing dishes such as roast chicken, it is recommended to put 2 sheets of aluminum foils on a tray in order to diminish oil splashing. Put one on a tray. Then oil will drip to a gap between foils .

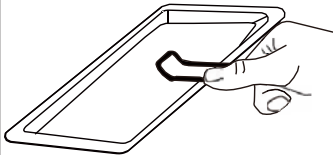

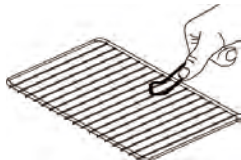
USE INDICATION

Bake Tray and Wire Rack		
	Food(For Ref. only)	How to use Tray Handle
<p>Bake Tray</p>  <p>Recommended to use it as crumb tray</p>	<p>Roast Chicken Wings, Hamburg steak, Gratin, Cake, almost all other oven-cooked foods</p>	
<p>Wire Rack</p> 	<p>Baked potatoes, Dry food</p>	
<p>Bake Tray and Wire Rack</p> 	<p>For food which will drip, e.g. boiled fish, etc.</p>	

The trays are not perfectly square.

Note:

Be careful when removing pudding and other hot liquids.

Rack Support

You can adjust the Tray at 2 different positions according to the dishes you want to cook. For instance, when making macaroni gratin and you want to have the top part cooked the most, use the top or the second rack support. For roasting a chicken, use the bottom rack support.

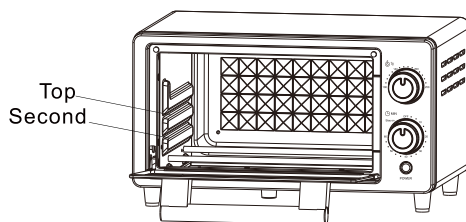

FUNCTION CONTROL

1. Set the "Temperature Control" by turning clockwise to select the suitable temperature according to the dishes you are going to cook.

Temperature Control ranging from "100°C" to 250°C.

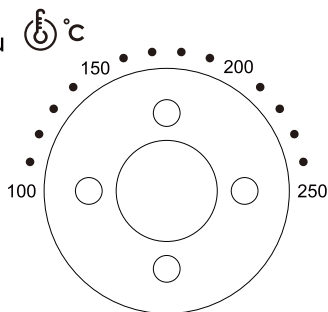

METHOD OF CLEANING



Take off the plug and cool down before cleaning.

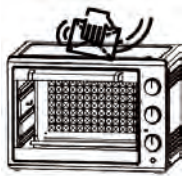

When cleaning, wash the interior and exterior surface, tray, grid, and rotisserie fork with soft cotton (or sponge) with neutral cleaner. Then wash with clean water. Do not use hard brush or any others to wash, so as not to scrape the interior surface of the oven, and to protect the tray, the wire rack and the rotisserie fork.



Do not use the toxic and abrasive cleaners such as gasoline, polishing powder, solvent.

BAKING REFERENCE OF COMMON FOOD

Type of food	Number or thickness	Temperature(°C)	Timer(min.)
Sandwich	2-3 pcs	200	2-3
Toast	2-4 pcs	250	2-5
Hamburger	2-3 pcs	200	3-5
Fish	/	200	7-10
Ham	2 cm	200	7-12
Sausage	3-4 pcs	200-230	8-10
Cake	/	150	20-30
Steak	1-2 cm	230	10-15
Chicken	Half chicken	175-200	30-40

OPERATING INSTRUCTIONS

Before using the unit for the first time:

Heat the empty oven:

1) Insert the tray and wire rack.

2) Set the temperature control dial to "250°C" and heat the empty oven for about 10 minutes.

Note:

There may be some smoke and a burning smell at first use, but this is not a malfunction.

Temperature control dial:

Set the Temperature Control Dial for the dishes which you are going to cook

1. Set the arrow on the timer knob to the number which indicates the cooking time (minutes) according to the dishes you are going to cook.

2. Set the Timer by turning it clockwise. The oven will turn off automatically at the end of the selected time and a bell will ring

- When setting the Timer to less than 5 min, turn it to more than 6 min. and then back to the selected time.

3. The oven can be turned off manually during cooking by turning the Timer counter-clockwise to the "OFF" position.

In case of "Stay On" mode, you have to disable the timer manually as the latter cannot be adjusted automatically.

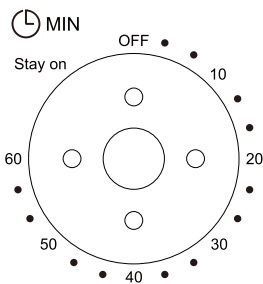

Note:

If the inside of the oven is dirty, cooking may take slightly longer than usual.

CAUTIONS

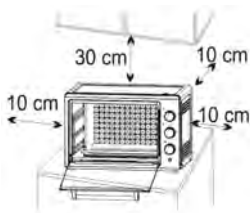

If the oven is positioned too close to a wall, the wall will be burned or stained. Be sure the curtain, etc. are not in contact with the body. Do not put anything between the bottom of the body and the surface on which it is set. An object so placed could be burned



Do not put anything on the oven while using it, the heat could cause deformation, cracking, etc.

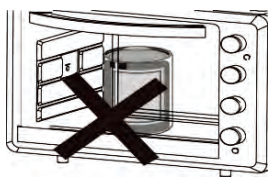

Any bottled or tinned food can not be heated directly as the bottle or tin would be broken out and scald the person.

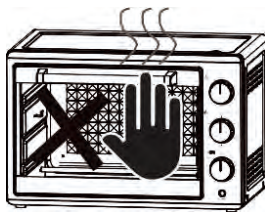

Be careful! Not to burn yourself during use or immediately after use. The metal parts and glass window of the door become extremely hot during use. Be careful not to touch them when opening and closing the door.

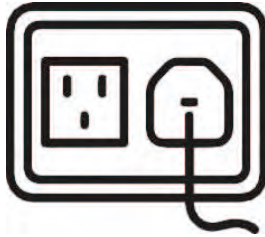

AC power must be taken from a properly wired outlet. Insert the plug completely into the socket. If it is not, it could become abnormally hot. Do not use an electric light outlet. Never connect multiple plugs to the same outlet

IMPORTANT SAFEGUARDS

Follow basic safety precautions, including:

1. Read all instructions.
2. Do not touch hot surfaces. Use handles or knobs.
3. To protect against risk of electrical shock, do not immerse cord, plugs or cooking unit in water or other liquid.
4. Close supervision is necessary when any appliance is used by or near children.
5. The appliance is not intended for use by young children or infirm persons without supervision.
6. Young children should be supervised to ensure that they do not play with the appliance.
7. Unplug from outlet when not in use and before cleaning. Allow to cool before putting on or taking off parts and before cleaning the appliance.
8. Do not operate any appliance with a damaged cord or plug or after the appliance malfunctions, or is dropped or damaged in any manner. Return appliances to the nearest authorized service facility for examination, repair, electrical or mechanical adjustment.
9. The use of accessory attachments, not recommended or sold by the appliance manufacturer, may cause hazards.
10. Do not use outdoors.

11. Do not allow the cord to hang over the edge of a table or counter, or touch hot surfaces.
12. Do not place on or near a hot gas or electric burner, or in a heated oven.
13. Extreme caution must be used when moving an appliance containing hot oil or other hot substances.
14. To disconnect, remove plug from wall outlet.
15. Do not use appliance other than for its intended use.
16. If the external flexible cable or cord of this appliance is damaged, it shall be exclusively replaced by the manufacture or his service agent or a similar qualified person in order to avoid a hazard.
17. This appliance is not intended for use by persons (including children) with reduced physical, sensory or mental capabilities, or lack of experience and knowledge, unless they have been given supervision or instruction concerning use of the appliance by a person responsible for their safety. Children should be supervised to ensure that they do not play with the appliance.
18. This appliance is not intended to be operated by means of an external timer or separate remote-control system.
19. This appliance is for household use only.
20. No user-serviceable parts inside. Refer servicing to qualified service personnel.
21. A short power-supply cord is provided to reduce the hazards resulting from entanglement or tripping over a long cord. An extension cord may be used with care, however, the marked electrical rating should be at least as great as the electrical rating of this appliance. The extension cord should not be allowed to drape over the counter or tabletop where it can be pulled by children or tripped over.

Warning: Do not immerse in water or any liquid.

Attention: Turn off the oven before opening the door to ensure safety.

CAUTION FOR CHILDREN

This appliance is not intended for use by persons (including children) with reduced physical, sensory or mental capabilities, or lack of experience and knowledge, unless they have been given supervision or instruction concerning use of the appliance by a person responsible for their safety)

WARNING:

If the supply cord is damaged, the manufacturer or its service agent or a similarly qualified person in order to avoid a hazard must replace it.

SPECIAL WARNING:



Recycling symbol, don't dispose of the product with household refuse.

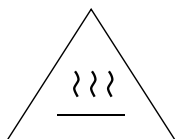

Caution: The temperature of the accessible surface may be high when the appliance is operating.



Dibuat untuk dan diedarkan oleh:
FIMACO SDN BHD
8-2, WISMA FIAMMA,
No.20, Jalan 7A/62A,
Bandar Manjalara, 52200 Kuala Lumpur, Malaysia.
CUSTOMER CARE CENTRE: +603 6279 8888.

