

How to use

Before using your dispenser for the first time, boil and discard one full pot of water by following the instructions below. You may notice a smell of plastic for the first time when you use the dispenser. This is normal and will fade over time.

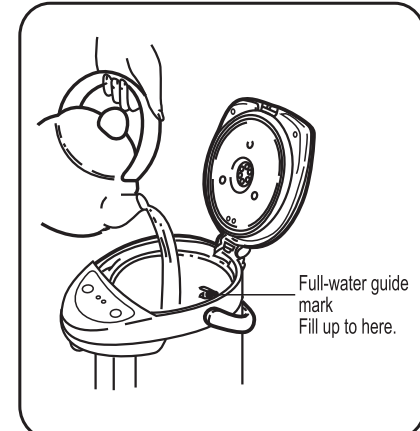

Fill the container by pouring cold water from another container such as a jug.

- Be sure the container filter is in place.
- Do not fill the container directly from the tap, as overflowing water could cause a short circuit or electric shock.
- Do not add water above full-water guide mark on the inside of the container. Hot water may overflow, causing scalds.
- Be careful not to splash water on the control panel or on the outside of the dispenser. Splashing water can damage the dispenser and cause an electric shock.

Close the lid.

- Carefully close the lid by pushing down until you hear a click.
- * You may hear a rattling sound when opening and closing the lid. This is normal.

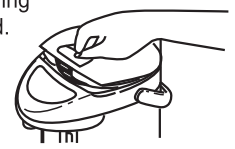

3

How to use

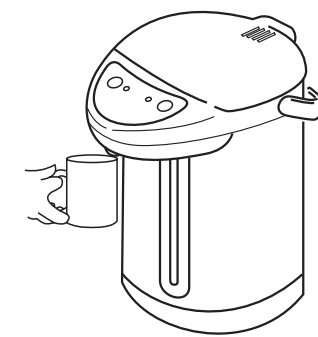

By pushing cup against spout switch

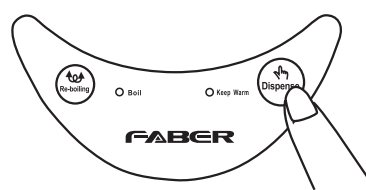

By pressing the dispense button on the control panel

4

How to use

Re-boil key When the dispenser is in keep-warm mode, use this key to re-boil the water.

Press the re-boil button.
The boil lamp will light.

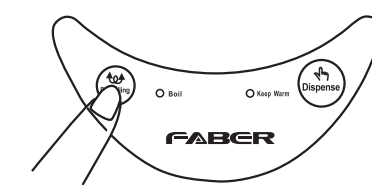

Once the water has re-boiled, the keep-warm lamp will light.

Re-boiling a full container takes about 5 minutes (at a room temperature of 20 degrees).
* Before re-boiling, make sure the water level is above the refill mark.
* The re-boil key has no effect right after the water has boiled.

When not in use

1. Unplug the dispenser and detach the lid.
2. Pour out remaining water

- * To avoid getting scalded, always detach the lid before pouring out the hot water.
- * Empty the container at least once a day. (Water left in the container can cause rusting, unpleasant odor, and accumulation of mineral deposits.)
- * Do not allow water to splash onto the operation panel, hinge, handle or power supply plug. (Splashed water can cause burns or damage the dispenser.)
- * Be careful not to lose the container filter.

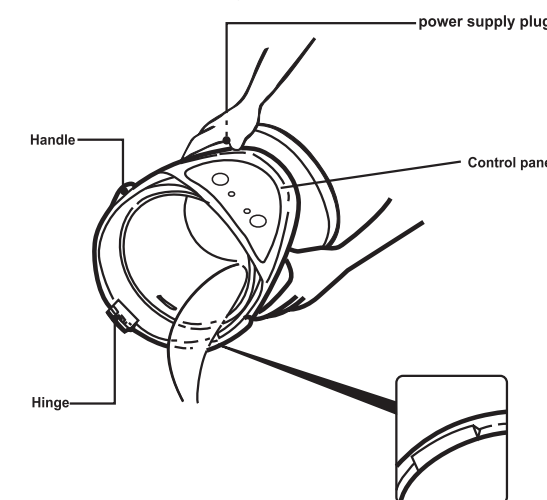

5

Parts Names

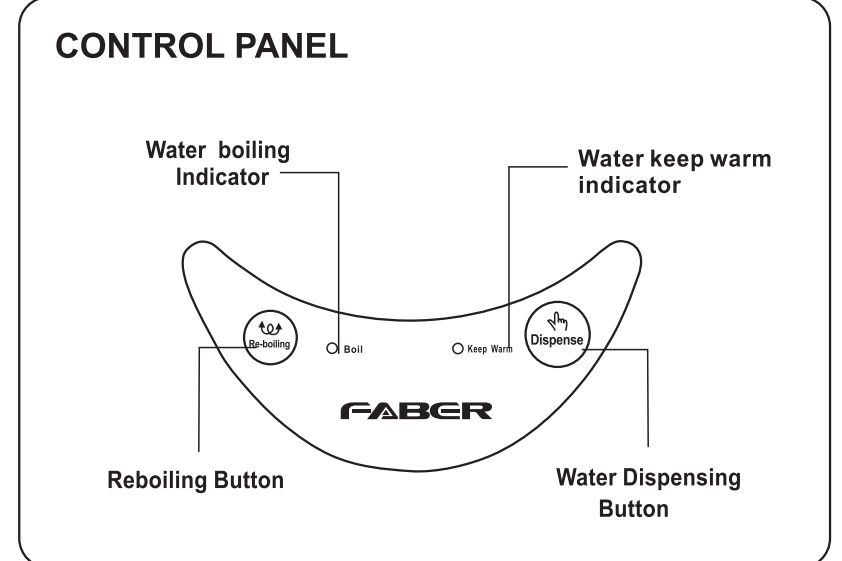

Specifications:-

Model No.	Capacity	Voltage	Power	Keep warm power
FTP Fantasia 606	6.0L	220-240V 50Hz	750W	35W

2

Precaution

Condition	Cause	Remedy
Water does not boil.	Plug is not plugged into electrical outlet. Metal object or dirt is on the tip of the magnetic plug.	Check the plug connections. Clean the tip of the magnetic plug.
Water does not become hot or does not pour properly.	Plug is not plugged into electrical outlet. Mineral deposits or the like have accumulated on the inner container and container filter. Hot water does not pour properly a few minutes after boiling.	Check the plug connections. Clean the container and the container filter. Open the upper lid once to release air bubbles. Close the lid. (Watch out for steam when opening the upper lid.) Pour out the excess amount of water until it is below the full-water guide mark.
Water pours out by itself.	Check that the pot is not filled beyond the full-water guide mark.	
White deposits appear in the hot water.	Deposits are formed by the mineral content of the water you are using. They are not due to corrosion of the non-stick fluorine coating.	Clean the inner container by boiling water mixed with citric acid
Loud boiling sounds can be heard.	Excessive accumulation of mineral deposits and the like on the inner container can cause loud boiling sounds.	
Hot water has a disagreeable odor.	The odor of chlorine may be detectable in your tap water. A mild plastic odor may be noticeable in a new dispenser. This odor will fade over time.	

WARNING - THIS APPLIANCE MUST BE EARTHED IMPORTANT

The wires in this mains lead are coloured in accordance with the following code:
Green-and-yellow:Earth Brown:Live Blue:Neutral
If the colours of the wires in the mains lead of this appliance do not correspond with the coloured markings identifying the terminals in your plug, proceed as follows.
The wire which is coloured green-and-yellow must be connected to the terminal in the plug which is marked with the letter E or by the earth symbol or coloured green or green-and-yellow. The wire which is coloured blue must be connected to the terminal which is marked with the letter N or coloured BLACK.
The wire which is coloured brown must be connected to the terminal which is marked with the letter L or coloured RED or Brown.

If the supply cord is damaged, it must be replaced by a special cord or assembly available from the manufacturer or its service agent.

How to precaution dry boil:

- 1) Over 24 hours not use, please take of the power wire.
- 2) Please add the water in inner pot when water level show without water.
- 3) Please avoid dry boil. Dry boil will cause a burn mark appear inside the inner pot and cannot be cleaned.
- 4) We are not responsible for any burn mark inside the inner pot where caused by dry boil.

7

FABER

ELECTRIC THERMO POT
FTP FANTASIA 606, 6.0L

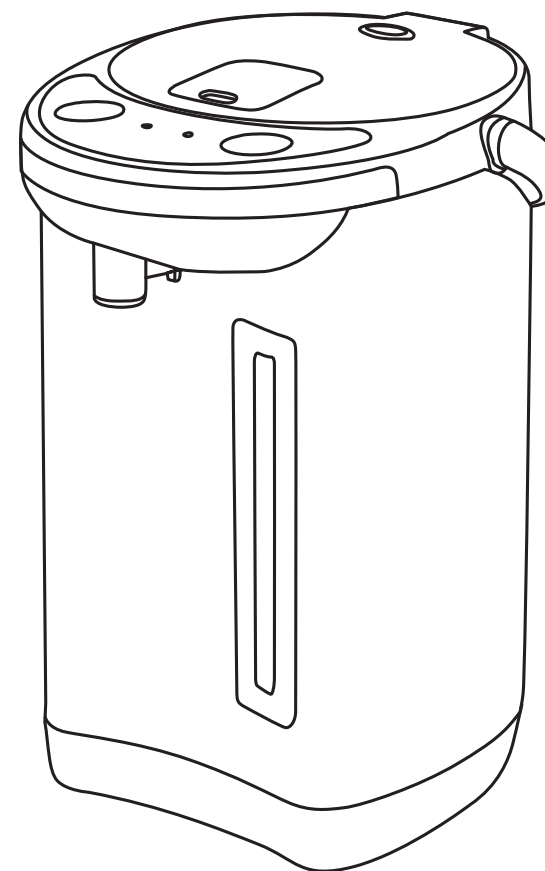

VOLTAGE : 220-240V FREQUENCY : 50/60Hz

INSTRUCTIONS MANUAL

PLEASE READ THIS INSTRUCTIONS MANUAL CAREFULLY BEFORE USING THIS PRODUCT

ELECTRIC THERMO POT

Parts Names

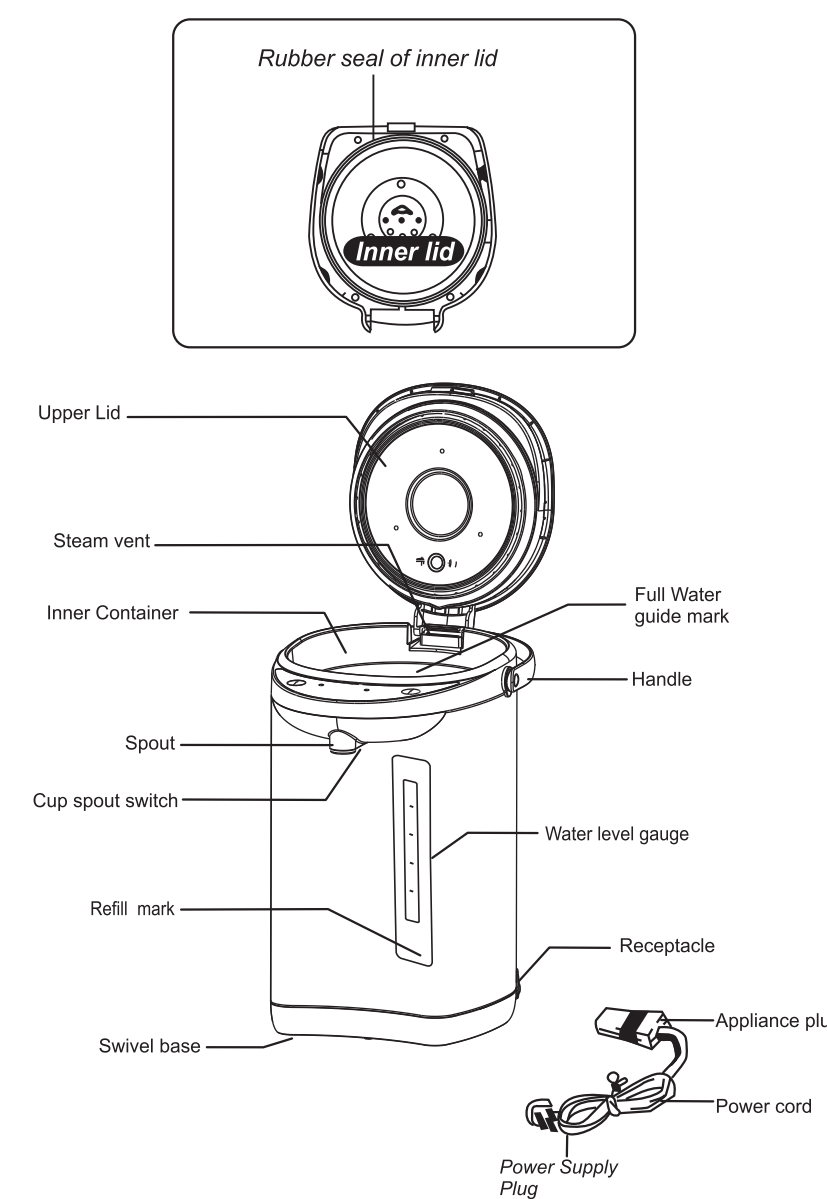

Note: Diagram differs depending on model.

1

Precaution

Caution	
<p>Do not allow pins or other metal objects to contact the magnetic appliance plug.</p> <ul style="list-style-type: none"> ● Contacting metal objects may cause electric shock, a shock circuit, and fire. <p>Always grasp the power supply plug when unplugging the power cord.</p> <p>Do not pull the power cord itself.</p> <ul style="list-style-type: none"> ● Doing so may cause an electric shock, a short circuit, or fire. <p>Do not attempt to pour hot water while it is boiling or immediately after it has boiled.</p> <ul style="list-style-type: none"> ● Hot water can spurt out and cause scalds. <p>Do not place the dispenser on an unstable surface or on surfaces that are vulnerable to heat.</p> <ul style="list-style-type: none"> ● Doing so may cause fire. 	<p>Unplug the electrical plug from the outlet when the dispenser is not being used.</p> <ul style="list-style-type: none"> ● The insulation could become damaged, resulting in injury, burns, electric shock, leakage of electricity, or fire. <p>To avoid burns, do not touch the steam vent.</p> <ul style="list-style-type: none"> ● Be especially careful that children do not touch it. ● Hot steam can scald your skin.

Notes	
<p>Do not turn on the dispenser if it is empty.</p> <ul style="list-style-type: none"> ● Doing so may cause fire or other damage. <p>Be careful when using the dispenser on a kitchen storage shelf or within 30 cm of a wall or furniture.</p> <ul style="list-style-type: none"> ● If steam contacts the ceiling, wall, or other items, it may cause discoloration or distortion of nearby objects or surfaces. <p>Do not use the dispenser near a heat source.</p> <ul style="list-style-type: none"> ● Doing so may cause fire or other damage. <p>Do not drag the dispenser.</p> <ul style="list-style-type: none"> ● It can scratch the surface of the table or counter. 	<p>Do not put ice, soup, milk, instant foods, tea, or any other substance except water into the dispenser.</p> <ul style="list-style-type: none"> ● Boiling water containing a tea bag, tea leaves, or instant foods can cause the water to foam and the contents of the pot to spurt out and burn you. It can also result in burning and decomposition of the food as well as peeling of the non-stick fluorine coating on the container. In addition, foreign objects may obstruct the internal electrical pump, preventing water from being dispensed.

6